

Main Lock Parts and Dimensions

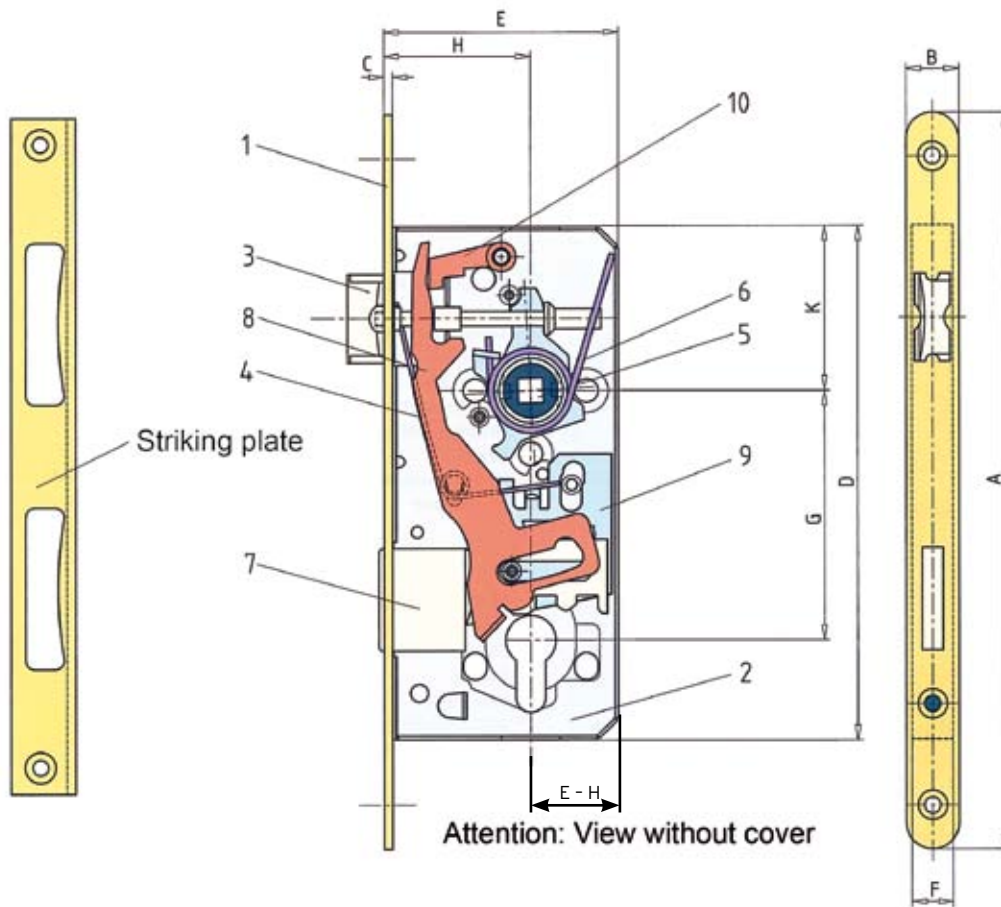

Main Lock Parts

- 1 Lock forend
- 2 Lock case
- 3 Lock latch
- 4 Latch retaining spring
- 5 Lock hub
- 6 Follower spring
- 7 Lock bolt
- 8 Latch lever
- 9 Pin
- 10 Latch stop
(for series 121.WZ and 127)

Main Lock Dimensions

- A Forend length
- B Forend width
- C Forend thickness
- D Case height
- E Case width
- F Case thickness
- G Center distance
- H Backset
- K Distance to middle
Follower hole
- E-H Rear backset

Symbol Legend



Bit key

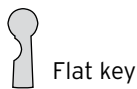

Flat key



WC- and
bath room



Latch configuration



Europrofile
cylinder



Europrofile cylinder
with latch lever



Swiss round
cylinder

Determining the direction

Single leaf door	Left inward
Door lock with latch lever	left
Hinges	left
Door furniture	left
Lever handle hole	left
Lever handle pin	right
Knob	outside
Handle outside	right

Single leaf door	Left outward
Door lock with latch lever	left
Hinges	left
Door furniture	right
Lever handle hole	right
Lever handle pin	left
Knob	outside
Handle outside	left

Single leaf door	Right inward
Door lock with latch lever	right
Hinges	right
Door furniture	right
Lever handle hole	right
Lever handle pin	left
Knob	outside
Handle outside	left

Single leaf door	Right outward
Door lock with latch lever	right
Hinges	right
Door furniture	left
Lever handle hole	left
Lever handle pin	right
Knob	outside
Handle outside	right

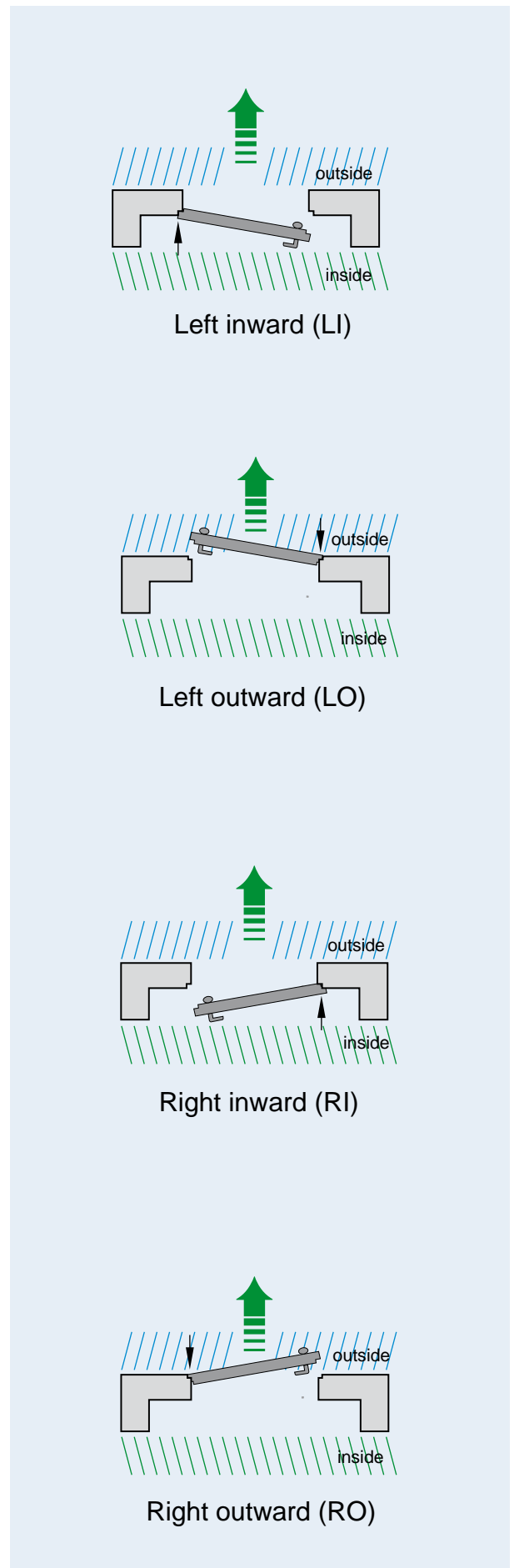

Gege DIN Door Lock Series 170



For inside doors up to 40 kg door weight - center distance 72 mm (78 mm for WC style)
 Lock styles bit key (BB), WC- and bath room doors (WC), Europrofile cylinders without latch lever (PZ),
 Europrofile cylinders with latch lever (WZ)

Specifications according to DIN 18251 Grade 2, BN12209
 Latch with latch stop, changeable right/left.
 Lock double throw, WC style single throw.
 Case and cover are made of sheet metal - 0.9 mm thick, ELO zinc plated
 Lock forend 235 x 18 x 3 mm or 235 x 20 x 3 mm in decor silver (DS), round (R).



170.BB



170.WC



170.PZ

All Dimensions in mm

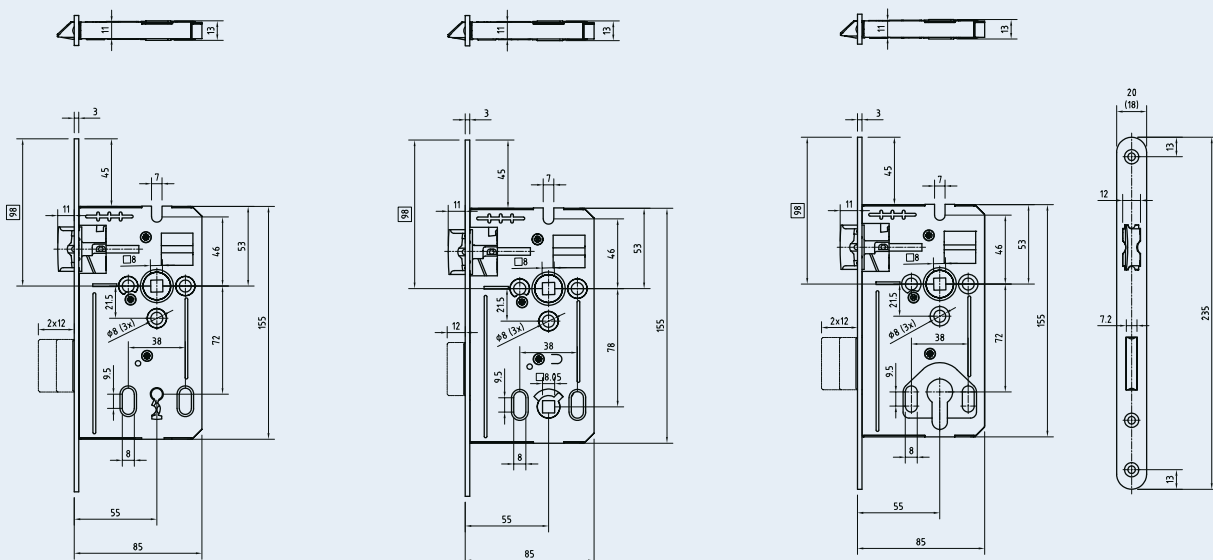

T.10_170BB.jpg

T.10_170WC.jpg

T.10_170PZ.jpg

Order Code	Lock style	Center dist.	Backset H	Case width E	Rear backset	Forend	Surface finish	Follower	Latch lever	Fire resistant
Forend 235 x 20 x 3 mm										
170.BB.R85.3.20.235.DS	Bit key	72	55	85	30	round 235 x 20 x 3	Decor silver	8,0	---	---
170.WC.R85.3.20.235.DS	WC	78	55	85	30	round 235 x 20 x 3	Decor silver	8,0	---	---
170.PZ.R85.3.20.235.DS	Europrofile cylinder	72	55	85	30	round 235 x 20 x 3	Decor silver	8,0	---	---
170.WZ.R85.3.20.235.DS	Europrofile cylinder	72	55	85	30	round 235 x 20 x 3	Decor silver	8,0	✓	---

Forend 235 x 18 x 3 mm

170.BB.R85.3.18.235.DS	Bit key	72	55	85	30	round 235 x 18 x 3	Decor silver	8,0	---	---
170.WC.R85.3.18.235.DS	WC	78	55	85	30	round 235 x 18 x 3	Decor silver	8,0	---	---
170.PZ.R85.3.18.235.DS	Europrofile cylinder	72	55	85	30	round 235 x 18 x 3	Decor silver	8,0	---	---
170.WZ.R85.3.18.235.DS	Europrofile cylinder	72	55	85	30	round 235 x 18 x 3	Decor silver	8,0	✓	---

• **Special Styles**

Forend: 220x20x3 mm, decor silver, yellow zinc plated

Forend: 235x24x3 mm, stainless steel, square

Backset: 50,60

WC-distance: 72 mm

Latch lock: Latch lock with latch lever

Designation CE, WZ fire resistant T60 (60 min.) in preparation

Follower 9mm

• **Latch stop:**

The latch stop is built into each lock with a latch lever and prevents the latch from moving behind the forend when in use.

• **Changing the latch position:**

The latch is changed by pressing it back into the lock case and turning it 180°. No tools are required. The lock must be held downward with the latch while changing its position.

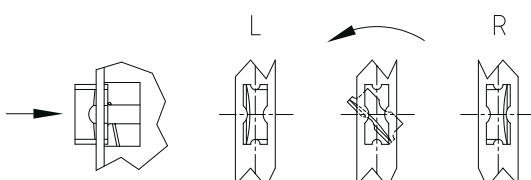

Gege DIN Door Lock Series 171



For main entrance doors in buildings - center distance 72 mm
Europrofile cylinder with latch lever (WZ) and bath and WC doors (WC)

Specification and dimensions to DIN 18250 Grade 4.
With spring loaded follower, lock bolt doublethrow
Case and cover are made of sheet metal - 0.9 mm thick, ELO zinc plated
Lock forend 235 x 20 x 3 mm in stainless steel (NR), round (R).



171.WZ.R65



171.WC.R65



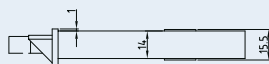
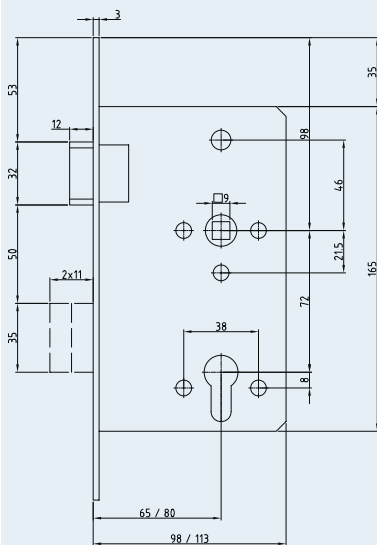



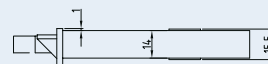
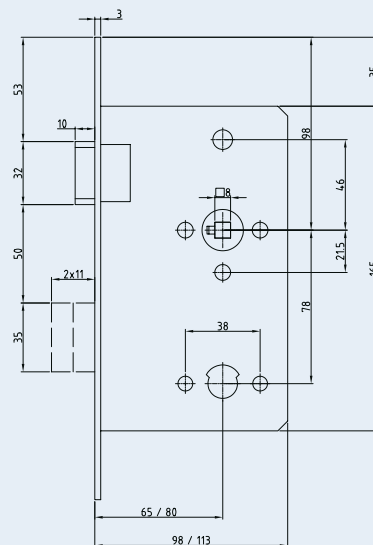
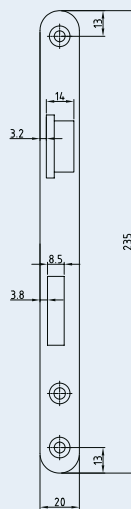





All Dimensions in mm



T.12_171WZ.jpg



T.12_171WC.jpg

Order Code	Lock style	Center dist.	Backset H	Case width E	Rear backset	Forend	Surface finish	Hub	Latch lever	Fire resistant
171.WZ.R70.20.235.KL4.NR.LI.T90	 Europrofile cylinder left	72	70	98	33	round 235 x 20 x 3	Stainless steel	9,0	✓	
171.WZ.R70.20.235.KL4.NR.RE.T90	 Europrofile cylinder right	72	70	98	33	round 235 x 20 x 3	Stainless steel	9,0	✓	
171.WZ.R80.20.235.KL4.NR.LI.T90	 Europrofile cylinder left	72	80	113	33	round 235 x 20 x 3	Stainless steel	9,0	✓	
171.WZ.R80.20.235.KL4.NR.RE.T90	 Europrofile cylinder right	72	80	113	33	round 235 x 20 x 3	Stainless steel	9,0	✓	
171.WC.R70.20.235.KL4.NR.LI	 left WC	78	70	98	33	round 235 x 20 x 3	Stainless steel	8,0	---	---
171.WC.R70.20.235.KL4.NR.RE	 right WC	78	70	98	33	round 235 x 20 x 3	Stainless steel	8,0	---	---
171.WC.R80.20.235.KL4.NR.LI	 left WC	78	80	113	33	round 235 x 20 x 3	Stainless steel	8,0	---	---
171.WC.R80.20.235.KL4.NR.RE	 right WC	78	80	113	33	round 235 x 20 x 3	Stainless steel	8,0	---	---